

# Dryer

## DP Series Parts Manual

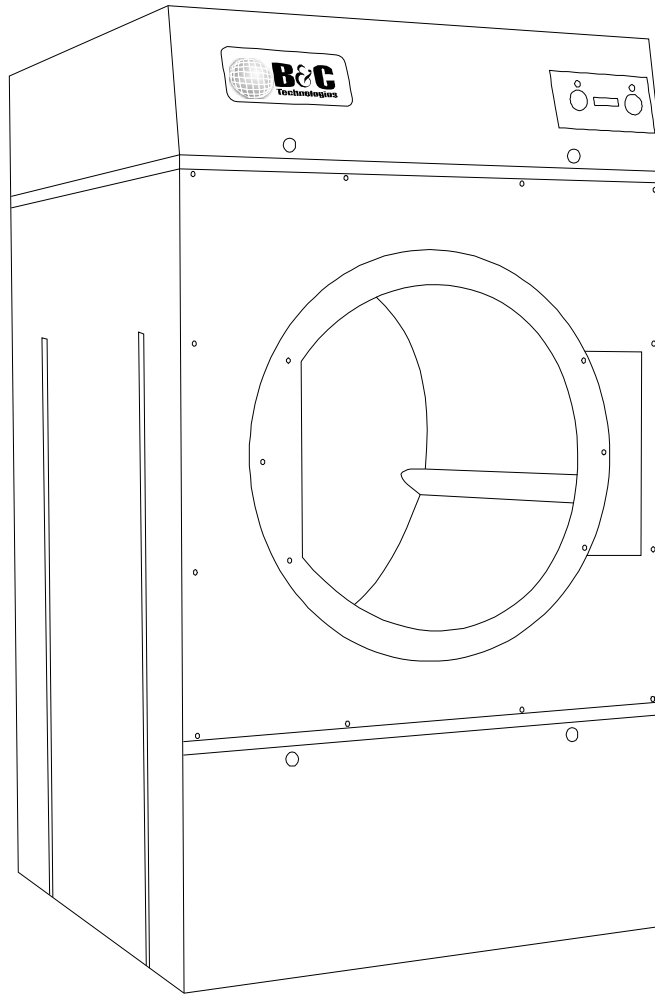

**B&C Technologies**

Panama City, FL

(850) 249-2222

(850) 249-2226 FAX

[www.bandctech.com](http://www.bandctech.com)

Revision 2.1  
14-May-2014



## **SECTION 8**

### **SERVICE/PART INFORMATION**

#### **A. SERVICE**

Service **must be** performed by a qualified trained technician, service agency, or gas supplier. If service is required, contact the distributor from whom the Dryer equipment was purchased. If the distributor cannot be contacted or is unknown, contact the Dryer Service Department for a distributor in your area.

**NOTE:** When contacting the Dryer Service Department, be sure to give them the correct **model number** and **serial number** so that your inquiry is handled in an expeditious manner.

#### **B. PARTS LIST**

Replacement parts **should be** purchased from the distributor from whom the Dryer equipment was purchased. If the distributor cannot be contacted or is unknown, contact the Dryer Parts Department for a distributor in your area. Parts may also be purchased directly from the factory

**NOTE:** When ordering replacement parts from the Dryer dealer or Dryer factory, be sure to give them the correct **model number** and **serial number** so that your parts order can be processed in an expeditious manner.



Item	Part No.		Qty.	Description
	DP200	DP250		
1	A2-SDP1-001	A2-SDP1-001	1	Panel, Front top
2	A2-SDP1-002	A2-SDP1-002	1	Panel, Front cabinet
3	A2-SDP1-003	A2-SDP1-003	1	Panel, Left side door
4	A2-SDP1-004	A2-SDP1-004	1	Panel, Right side door
5	A2-SDP1-005	A2-SDP1-005	1	Panel, Front center lower door cover
6	A2-SDP1-006	A2-SDP1-006	1	Panel, Front lower filter cover
7	A2-SDP1-007	A2-SDP1-007	1	Door lint drawer filter
8	A2-S200-009	A2-S250-009	1	Left panel assembly, Top
9	A2-S200-008	A2-S250-008	1	Left panel assembly
10	A2-S200-011	A2-S250-011	1	Right panel assembly, Top
11	A2-S200-010	A2-S250-010	1	Right panel assembly
12	A0-A090-010	A0-A090-010	1	Sticker "B&C" logo
13	A0-A013-002	A0-A013-002	6	Door lock

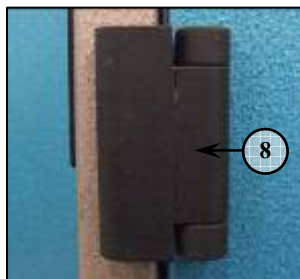
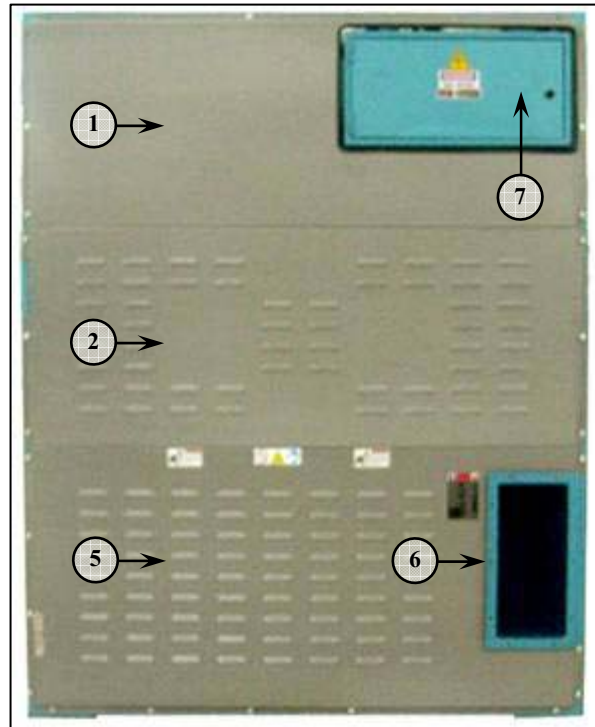
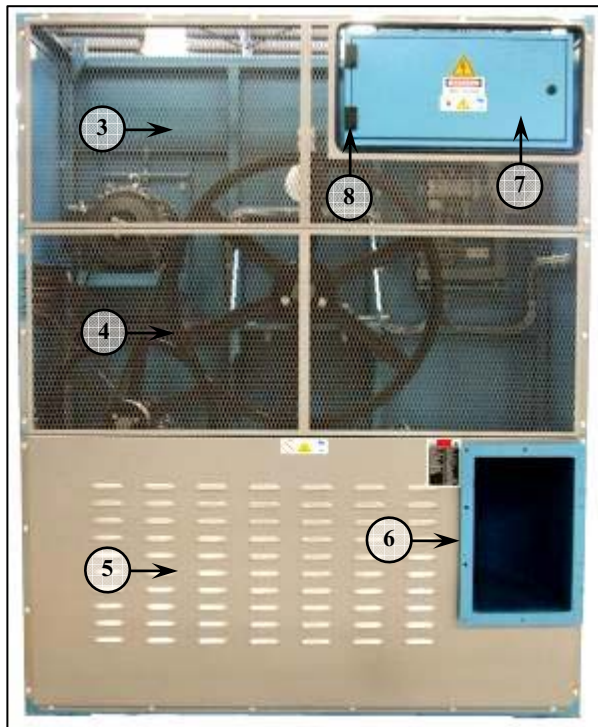

Item	Part No.		Qty.	Description
	DP200	DP250		
1	A2-S200-020	A2-S250-020	1	Panel, Rear assembly top
2	A2-S200-021	A2-S250-021	1	Panel, Rear assembly middle
3	A2-S200-038	A2-S250-038	1	Panel, Rear assembly top
4	A2-S200-039	A2-S250-039	1	Panel, Rear assembly middle
5	A2-S200-022	A2-S250-022	1	Panel, Rear assembly lower
6	A2-S200-012	A2-S250-012	1	Exhaust duct outlet
7	A2-SDP1-008	A2-SDP1-008	1	Box, Main electrical control
	A2-SDP1-009	A2-SDP1-009	1	Cover, Main electrical control
8	A0-A029-005	A0-A029-005	2	Hinge, Off set panel door

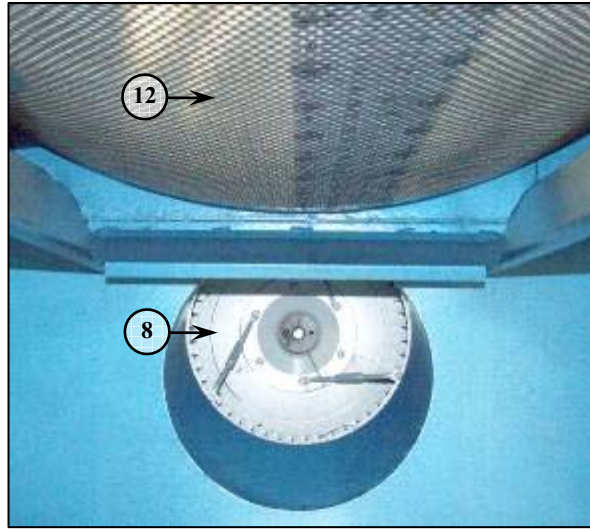
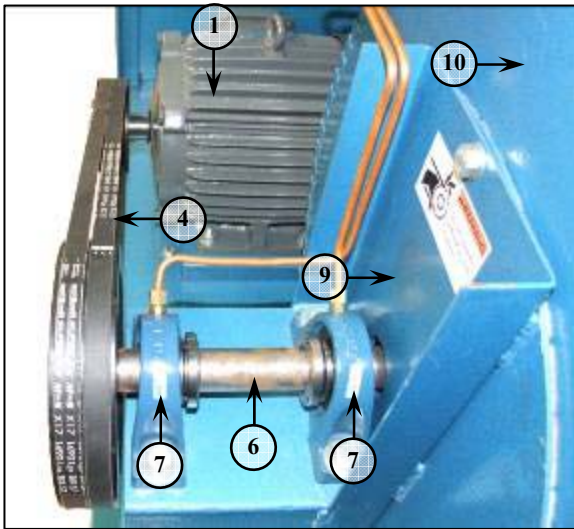
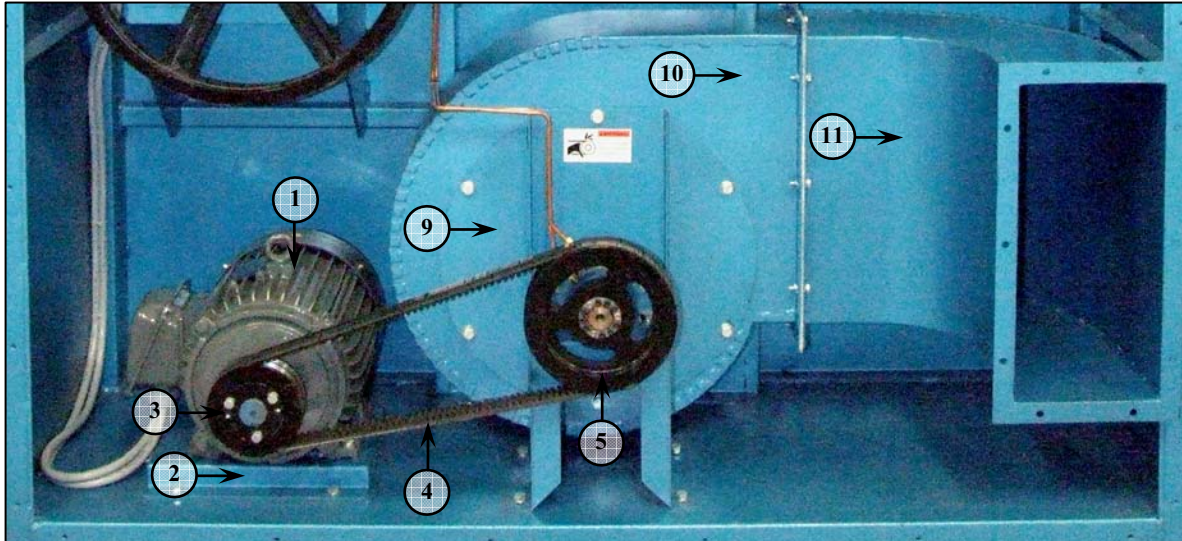

Item	Part No.		Qty.	Description
	DP200	DP250		
1	A0-E008-021	A0-E008-021	1	Suction fan motor (50Hz,220-415V-Steam,Gas)
	A0-TSE01-551	A0-TSE01-551	1	Suction fan motor (50Hz,660V-Steam,Gas)
	A0-E008-060	A0-E008-060	1	Suction fan motor (60Hz,220-415V-Steam,Gas)
2	A2-SDP1-010	A2-SDP1-010	1	Base, Motor suction fan (50Hz-Steam,Gas)
	A2-SDP1-011	A2-SDP1-011	1	Base, Motor suction fan (60Hz-Steam,Gas)
3	A0-M008-041	A0-M008-041	1	Suction fan motor pulley (50/60Hz-Steam,Gas)
	A0-M009-045	A0-M009-045	1	Suction fan motor sleeve (50/60Hz-Steam,Gas)
4	A0-A002-093	A0-A002-093	2	V-Belt
5	A0-M008-042	A0-M008-102	1	Suction fan pulley (50Hz-Steam)
	A0-M008-042	A0-M008-042	1	Suction fan pulley (50Hz-Gas)
	A0-M008-100	A0-M008-104	1	Suction fan pulley (60Hz-Steam)
	A0-M008-100	A0-M008-104	1	Suction fan pulley (60Hz-Gas)
	A0-M009-063	A0-M009-063	1	Suction fan sleeve
6	A0-M011-006	A0-M011-010	1	Suction fan shaft
7	A0-A004-029	A0-A004-044	2	Bearing
	-	A0-A006-124	2	Sleeve
8	A0-M003-007	A0-M003-008	1	Wheel suction fan
9	A2-S200-018	A2-S250-018	1	Base, Bearing suction fan
10	A2-S200-019	A2-S250-019	1	Housing suction fan
11	A2-S200-012	A2-S250-012	1	Exhaust duct outlet
12	A2-S200-027	A2-S250-027	1	Basket stainless steel

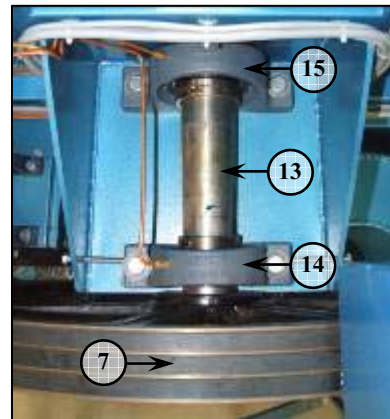
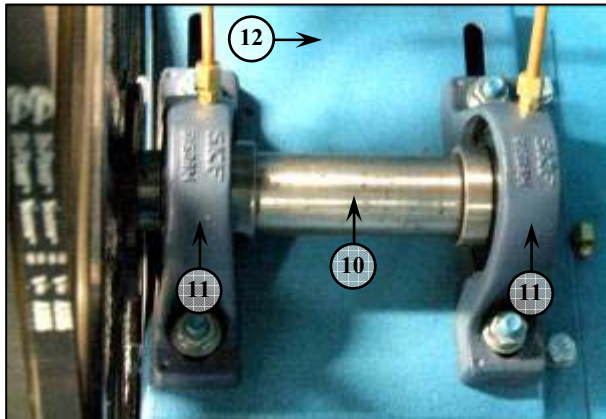
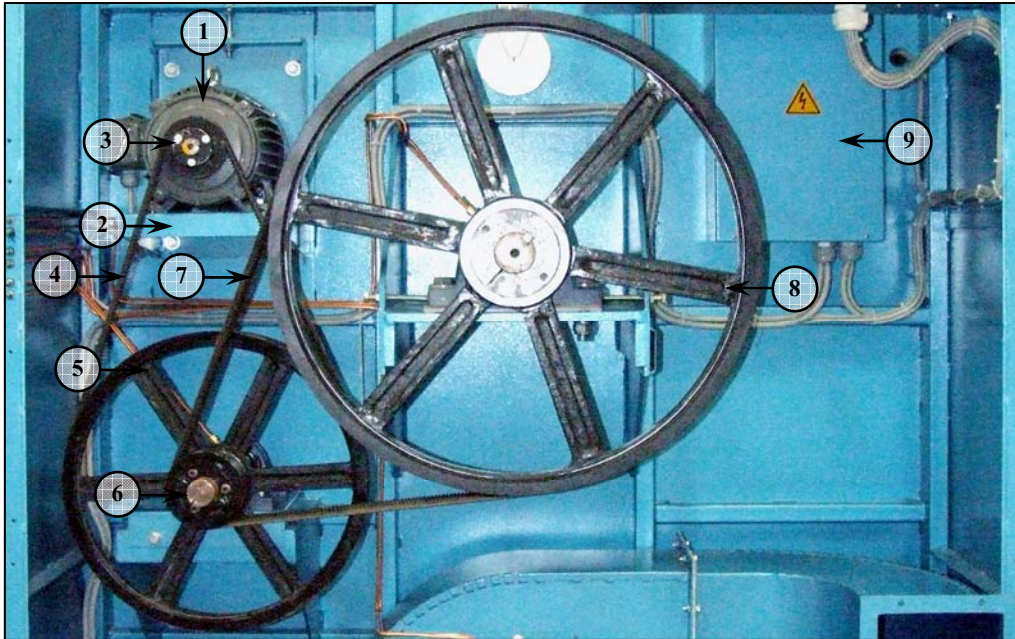

Item	Part No.		Qty.	Description
	DP200	DP250		
1	A0-E008-058	A0-E008-232	1	Basket motor (50/60Hz-Steam,Gas)
2	A2-S200-015	A2-S250-015	1	Base, Basket motor
3	A0-M008-039	A0-M008-076	1	Basket motor pulley (50Hz-Steam,Gas)
	A0-M008-101	A0-M008-105	1	Basket motor pulley (60Hz-Steam,Gas)
	A0-M009-044	A0-M009-064	1	Basket motor sleeve (50/60Hz-Steam,Gas)
4	A0-A002-005	A0-A002-005	2	V-Belt
5	A0-M008-040	A0-M008-040	1	Idler-Motor pulley
	A0-M009-065	A0-M009-065	1	Idler-Motor sleeve
6	A0-M008-038	A0-M008-038	1	Idler-Basket pulley
	A0-M009-072	A0-M009-072	1	Idler-Basket sleeve
7	A0-TSA01-281	A0-TSA01-281	3	V-Belt
8	A0-M008-037	A0-M008-037	1	Basket pulley (50/60Hz-Steam,Gas)
	A0-M009-067	A0-M009-067	1	Basket sleeve (50/60Hz-Steam,Gas)
9	A2-SDP1-012	A2-SDP1-012	1	Box, Blower electrical control
	A2-SDP1-013	A2-SDP1-013	1	Cover, Blower electrical control
10	A0-M011-005	A0-M011-012	1	Idler shaft
11	A0-A004-160	A0-A004-160	2	Bearing
12	A2-S200-016	A2-S200-016	1	Base, Idler pulley
13	A0-M011-004	A0-M011-011	1	Basket shaft
14	A0-A004-144	A0-A004-144	1	Bearing
15	A0-A004-145	A0-A004-145	1	Bearing



Item	Part No.		Qty.	Description
	DP200	DP250		
1	A2-SDP1-002	A2-SDP1-002	1	Panel, Front cabinet
2	A2-SDP1-003	A2-SDP1-003	1	Panel, Left side door
3	A2-SDP1-004	A2-SDP1-004	1	Panel, Right side door
4	A0-A003-011	A0-A003-011	1	Door glass
5	A2-SDP1-014	A2-SDP1-014	1	Door ring
6	A2-SDP1-015	A2-SDP1-015	1	Door handle
7	A2-SDP1-016	A2-SDP1-016	1	Hinge and hinge shaft
8	A2-SDP1-017	A2-SDP1-017	1	Door hinge bracket, Top
9	A2-SDP1-018	A2-SDP1-018	1	Door hinge bracket, Lower
10	A0-A036-004	A0-A036-004	1	Magnet latch
	A2-SDP1-019	A2-SDP1-019	1	Magnet latch bracket
11	A0-E011-015	A0-E011-015	1	Door switch
12	A2-SDP1-005	A2-SDP1-005	1	Panel, Front center lower door cover
13	A2-SDP1-006	A2-SDP1-006	1	Panel, Front lower filter cover
14	A2-SDP1-007	A2-SDP1-007	1	Door lint drawer filter
15	A0-A043-007	A0-A043-011	1	Filter
16	A0-E015-011	A0-E015-011	1	Lint drawer filter switch



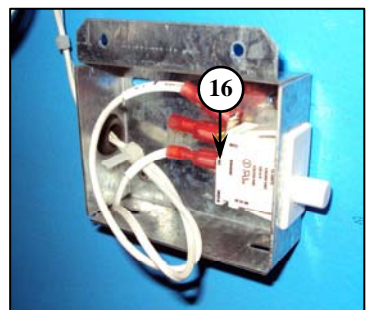
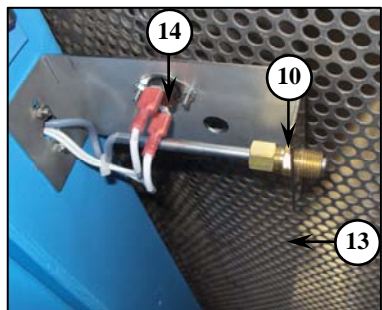
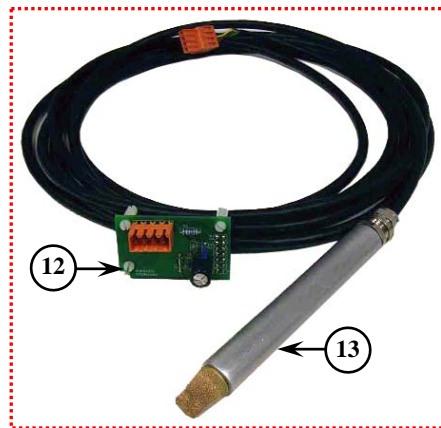
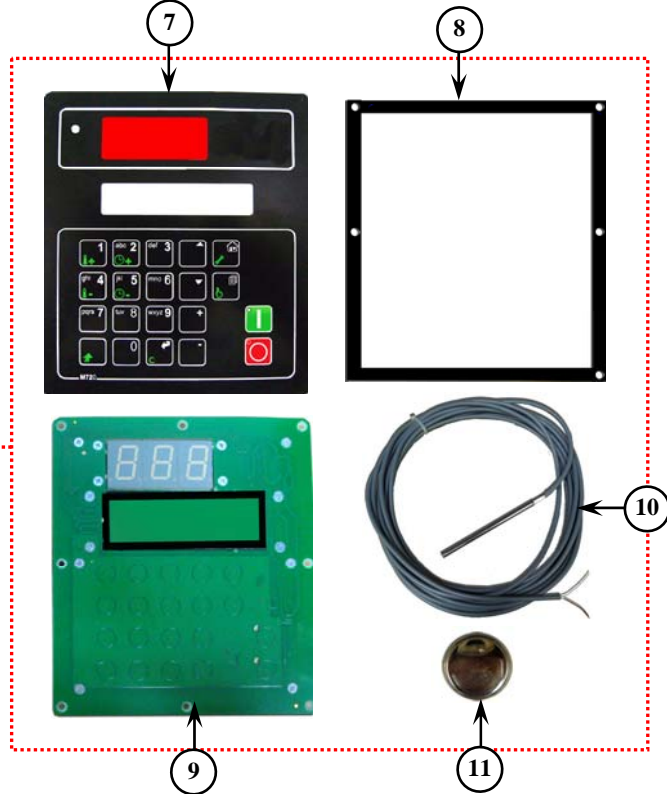

Item	Part No.	Qty.	Description
1	A0-E032-018	1	Emergency Stop
2	A0-E035-021	1	Pilot light (Blue)
3	A0-E032-009	1	Push button switch (Green)
4	A0-E032-007	1	Push button switch (Red)

<b>Item</b>	<b>Part No.</b>	<b>Qty.</b>	<b>Description</b>
5	A0-E059-005	2	Lamp, Indicator, Red (for Gas type)
6	A0-E007-168	1	Mobics M720 Dryer Controller
7	A0-A090-043	1	Decal Mobics
8	A0-A150-001	1	Gasket Froan rubber size150mmX165mmX1.5mm
9	A0-E007-109	1	M721 controller
10	A0-E027-055	1,2	Temperature probe with cable PT100
11	A0-X022-120	1	Lithium battery"VARTA" Model CR2032 LI-Mn 3V
12	A0-TSEN01-1470	1	M703B Sersor Probe cable long 3.2 m 4 P
13	A0-TSEN01-1471	1	M703A PCB connect Sersor Probe
14	A0-E016-011	2	Thermostat
15	A2-S250-027	1	Basket stainless steel include spider and shaft
16	A0-E015-011	1	Door over travel switch



Item	Part No.		Qty.	Description
	DP200	DP250		
1	A0-A090-039	A0-A090-039	1	Decal for microprocessor controller (EDG)
2	A2-SDP1-020	A2-SDP1-020	1	Controller plate (For EDG)
3	A0-E007-004	A0-E007-004	1	Microprocessor controller (EDG)
4	A0-E027-010	A0-E027-010	1	Temperature probe
5	A0-E016-011	A0-E016-011	1	Thermostat
6	A0-E032-018	A0-E032-018	1	Emergency Stop
7	A0-E035-021	A0-E035-021	1	Pilot light for filter alarm
8	A0-E032-009	A0-E032-009	1	Switch for start the machine
9	A0-E032-007	A0-E032-007	1	Switch for stop the machine
10	A0-E059-005	A0-E059-005	1	Indicator lamp (Red)

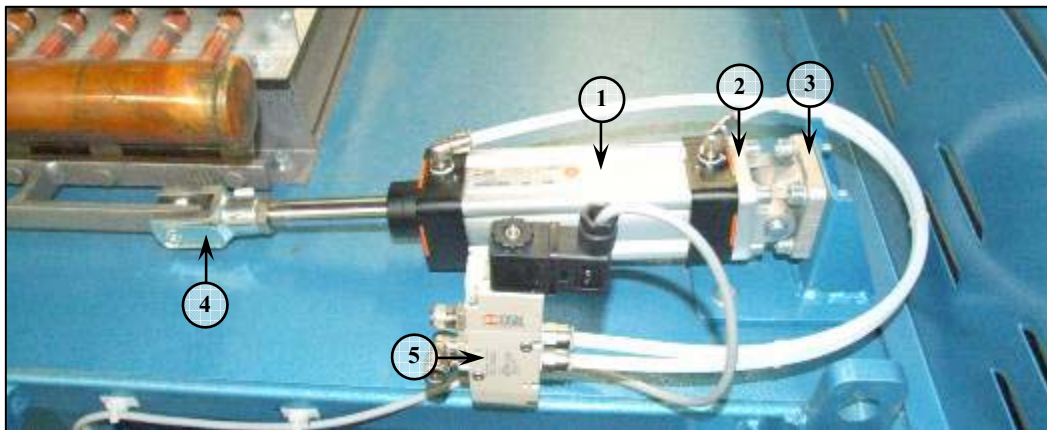
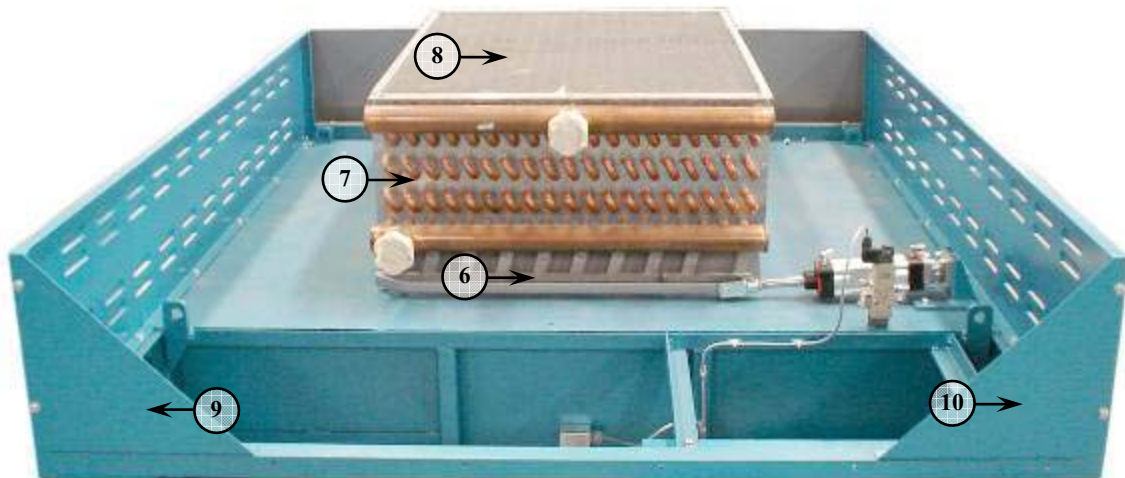

Item	Part No.		Qty.	Description
	DP200	DP250		
1	A0-P003-022	A0-P003-022	1	Air cylinder (For damper steam)
2	A0-A015-002	A0-A015-002	1	Trunnion
3	A0-A015-008	A0-A015-008	1	Trunnion
4	A0-A014-002	A0-A014-002	1	Rod fork
5	A0-P005-137	A0-P005-137	1	Air solenoid valve
6	A2-SDP1-024	A2-SDP1-024	1	Steam damper
7	A0-A026-006	A0-A026-009	1	Steam coil
8	A2-SDP1-021	A2-SDP1-021	1	Filter, Steam coil
9	A2-SDP1-022	A2-SDP1-022	1	Bracket, Panel support top rear, Left
10	A2-SDP1-023	A2-SDP1-023	1	Bracket, Panel support top rear, Right

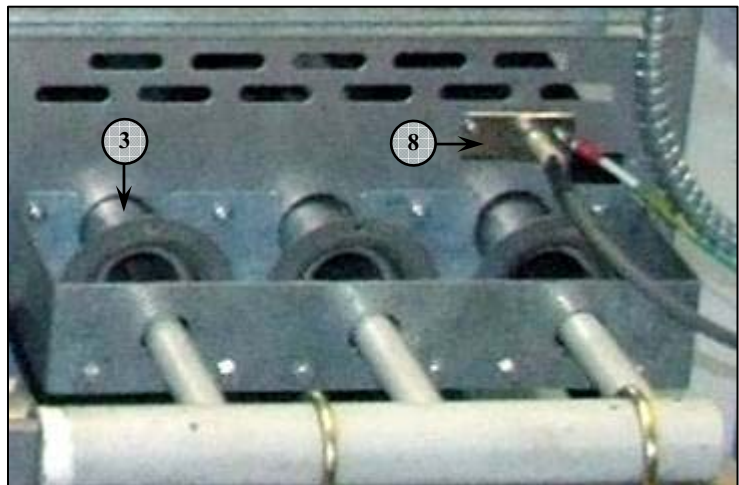
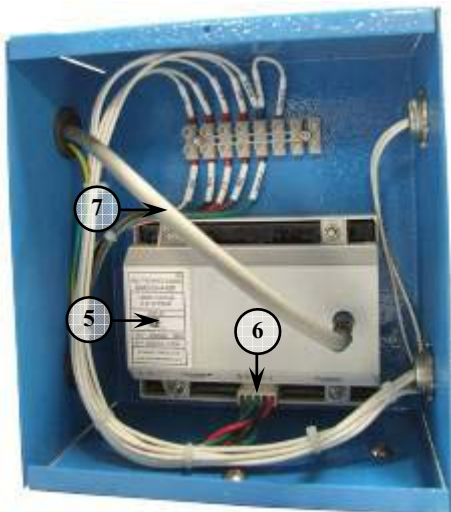
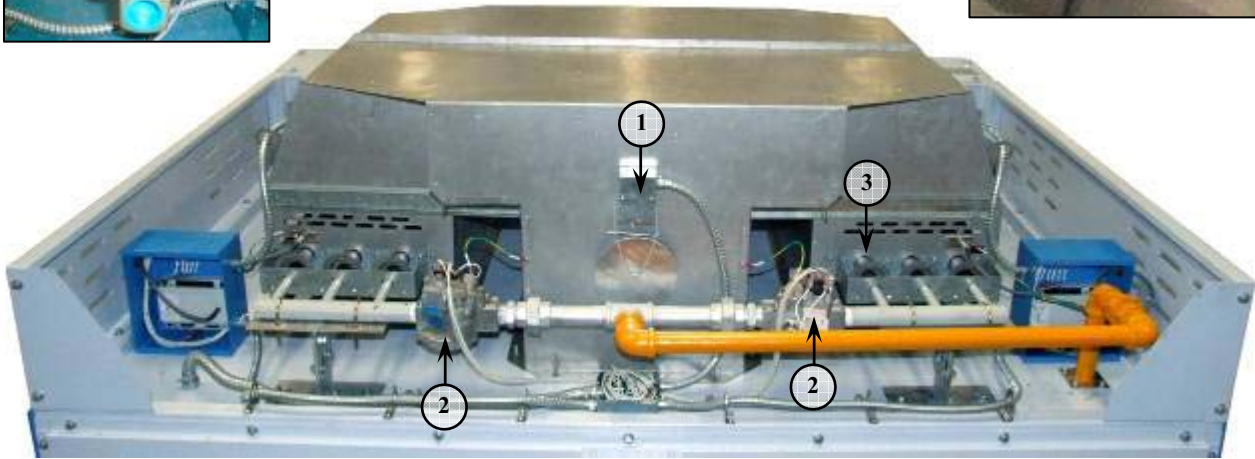
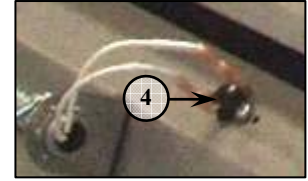

Item	Part No.		Qty.	Description
	DP200	DP250		
1	A0-E014-010	A0-E014-010	2	Safety switch
2	A0-E018-003	A0-E018-003	2	Gas valve
3	A0-A089-002	A0-A089-002	6	Gas burner tube
4	A0-E016-013	A0-E016-013	2	Thermostat for safety high temp.
5	A0-E020-001	A0-E020-001	2	Ignition control
6	A0-E020-202	A0-E020-202	2	Wiring harnesses
7	A0-E019-006	A0-E019-006	2	Wire, Suppression
8	A0-E019-005	A0-E019-005	2	Spark probe
9	A0-E040-008	A0-E040-008	1	Water solenoid valve

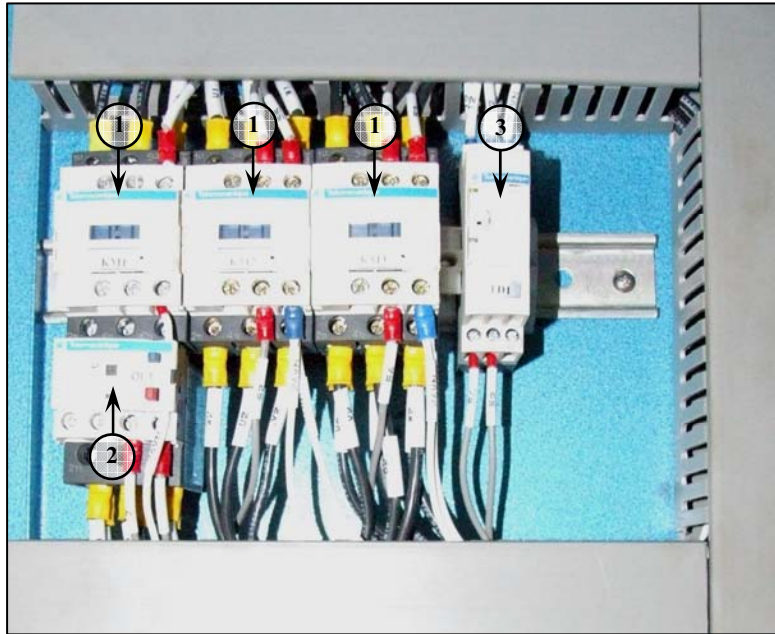

Item	Part No.		Qty.	Description
	DP200	DP250		
1	A0-E004-003	A0-E004-003	3	Magnetic contactor (208-240V)
	A0-E004-001	A0-E004-001	1	Magnetic contactor (380-440V)
2	A0-E025-010	A0-E025-010	1	Overload (208-240V)
	A0-E025-026	A0-E025-026	1	Overload (380-440V)
3	A0-E031-009	A0-E031-009	1	Timer relay
4	A0-E006-031	A0-E006-031	1	Transformer
5	A0-E026-010	A0-TSE01-086	1	Soft start (208-240V)
	A0-E026-006	A0-E026-010	1	Soft start (380-440V)
6	A0-E004-011	A0-E004-011	2	Magnetic contactor
7	A0-E025-020	A0-E025-020	1	Overload
8	A0-E009-070	A0-E009-070	1	Relay
	A0-E009-071	A0-E009-071	1	Socket relay
9	A0-E010-029	A0-E010-029	1	Breaker 6A
	A0-E010-034	A0-E010-034	2	Breaker 3A

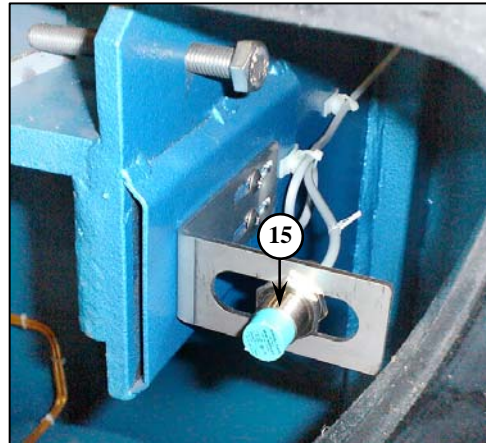
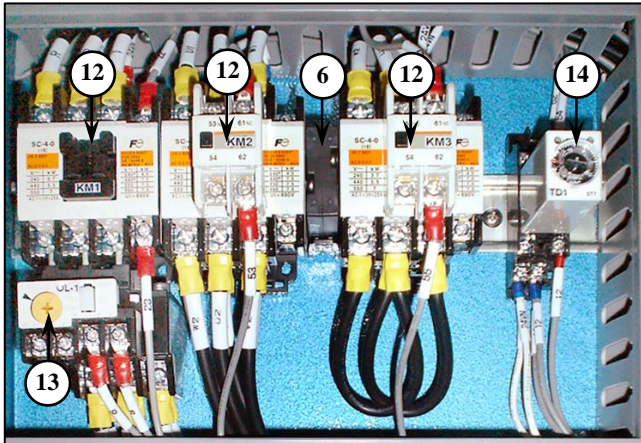
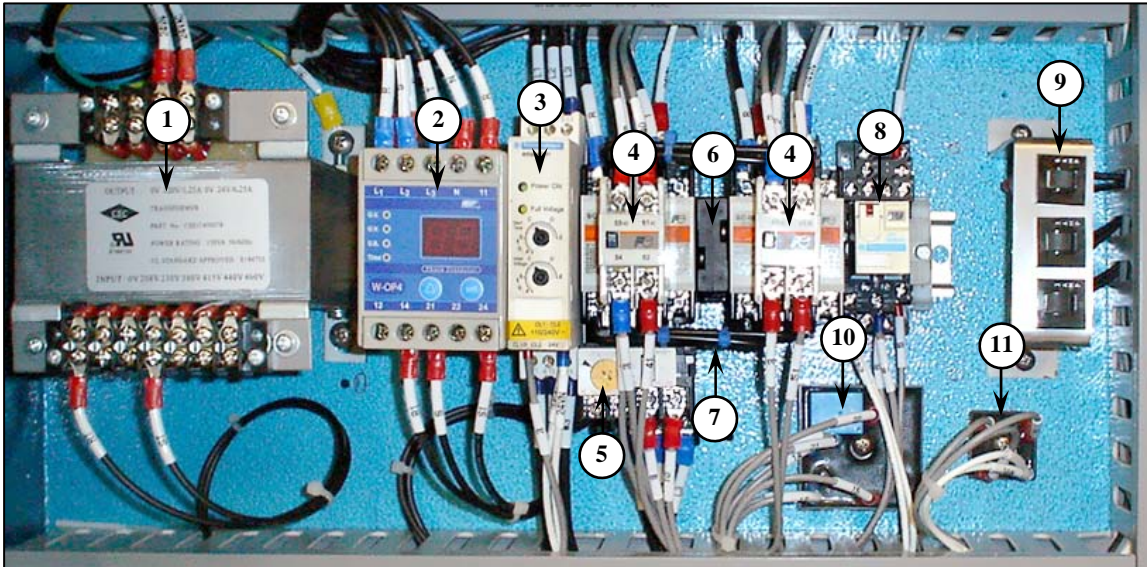

Item	Part No.		Qty.	Description
	DP200	DP250		
1	A0-E006-031	A0-E006-031	1	Transformer
2	A0-E010-024	A0-E010-024	1	Open phase protection (Specail)
3	A0-E026-011	A0-TSE01-086	1	Soft start (208-240V)
	A0-E026-006	A0-E026-011	1	Soft start (380-440V)
4	A0-E004-065	A0-E004-065	2	Magnetic contactor
	A0-E024-011	A0-E024-011	2	Auxiliary contact
5	A0-E025-055	A0-E025-055	1	Overload
6	A0-E036-006	A0-E036-006	2	Mechanical interlock
7	A0-E036-007	A0-E036-007	2	Power connection kit for reversing
8	A0-E009-070	A0-E009-070	1	Relay
	A0-E009-071	A0-E009-071	1	Socket relay
9	A0-E010-035	A0-E010-035	1	Breaker 2A
	A0-E010-029	A0-E010-029	1	Breaker 6A
	A0-E010-034	A0-E010-034	2	Breaker 3A
10	A0-E031-019	A0-E031-019	1	Watch dog timer
11	A0-E050-002	A0-E050-002	1	Bridge rectifier
12	A0-E004-071	A0-E004-071	3	Magnetic contactor (208-240V)
	A0-E004-069	A0-E004-069	3	Magnetic contactor (380-440V)
	A0-E024-011	A0-E024-011	2	Auxiliary contact
13	A0-E025-060	A0-E025-060	1	Overload (208-240V)
	A0-E025-058	A0-E025-058	1	Overload (380-440V)
14	A0-E031-025	A0-E031-025	1	Timer relay
	A0-E031-026	A0-E031-026	1	Socket timer relay
15	A0-E023-003	A0-E023-003	1	Proximity sensor

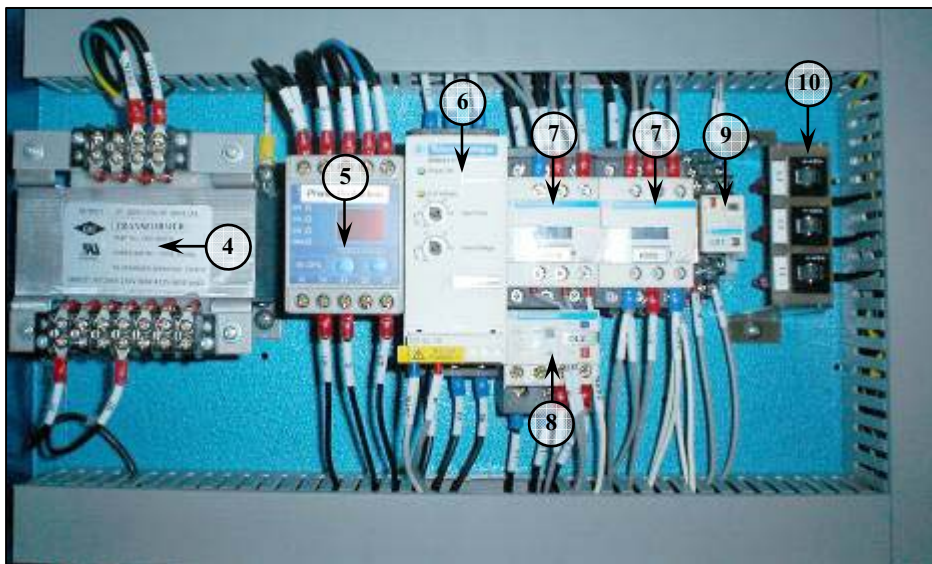
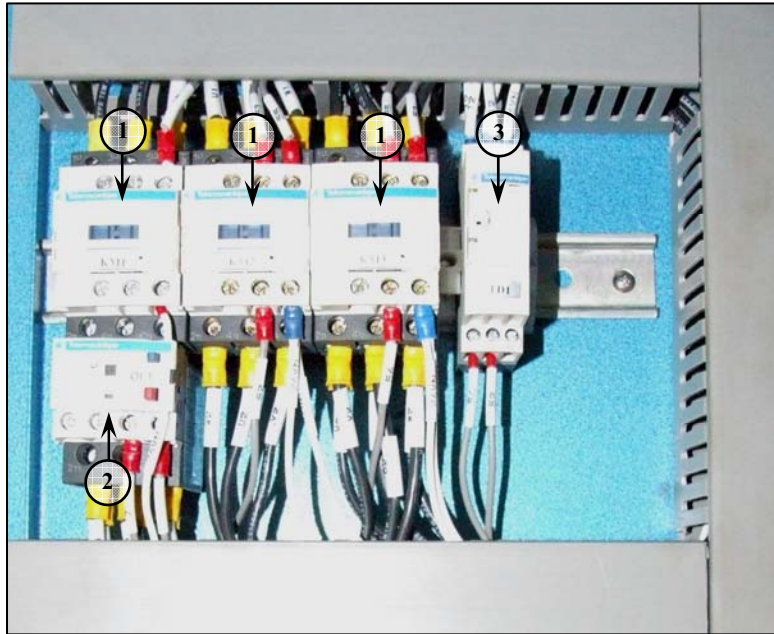

Item	Part No.		Qty.	Description
	DP200	DP250		
1	A0-E004-003	A0-E004-003	3	Magnetic contactor (208-240V)
	A0-E004-001	A0-E004-001	1	Magnetic contactor (380-440V)
2	A0-E025-010	A0-E025-010	1	Overload (208-240V)
	A0-E025-026	A0-E025-026	1	Overload (380-440V)
3	A0-E031-009	A0-E031-009	1	Timer relay
4	A0-E006-031	A0-E006-031	1	Transformer
5	A0-E010-024	A0-E010-024	1	Open phase protection
6	A0-E026-010	A0-TSE01-086	1	Soft start (208-240V)
	A0-E026-006	A0-E026-010	1	Soft start (380-440V)
7	A0-E004-011	A0-E004-011	2	Magnetic contactor
8	A0-E025-020	A0-E025-020	1	Overload
9	A0-E009-070	A0-E009-070	1	Relay
	A0-E009-071	A0-E009-071	1	Socket relay
10	A0-E010-029	A0-E010-029	1	Breaker 6A
	A0-E010-034	A0-E010-034	2	Breaker 3A



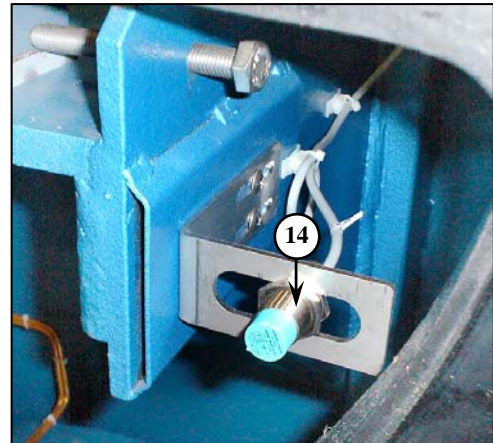
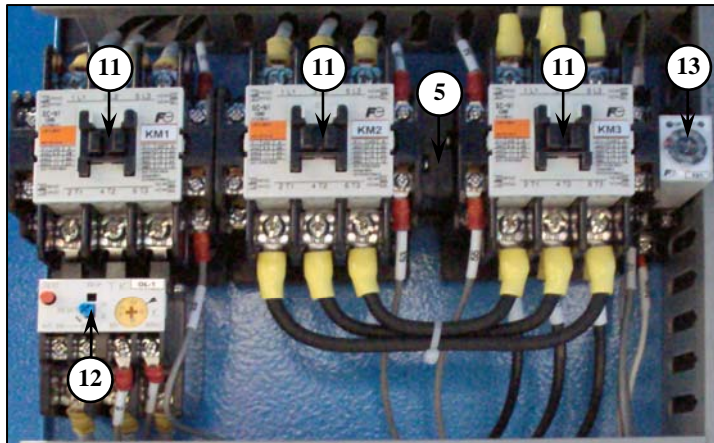
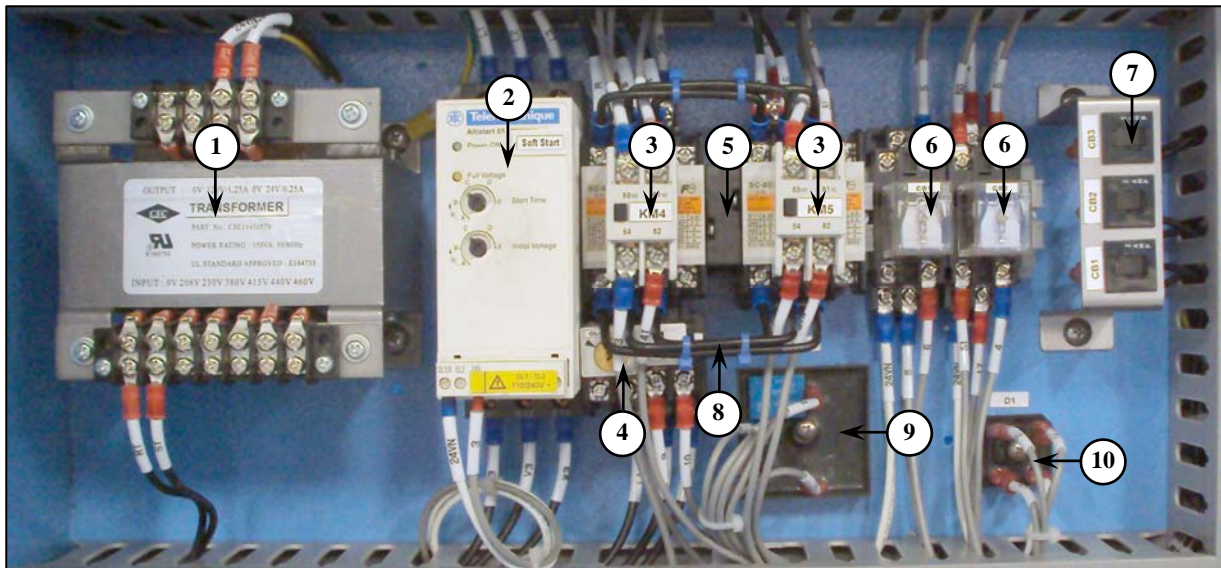

Item	Part No.		Qty.	Description
	DP200	DP250		
1	A0-E006-031	A0-E006-031	1	Transformer
2	A0-E026-010	A0-TSE01-257	1	Soft start (208-240V)
	A0-E026-006	A0-E026-010	1	Soft start (380-440V)
3	A0-E004-065	A0-E004-065	2	Magnetic contactor
	A0-E024-011	A0-E024-011	2	Auxiliary contact
4	A0-E025-055	A0-E025-055	1	Overload
5	A0-E036-006	A0-E036-006	2	Mechanical interlock
6	A0-E009-082	A0-E009-082	2	Relay
	A0-E009-083	A0-E009-083	2	Socket relay
7	A0-E010-035	A0-E010-035	1	Breaker 2A
	A0-E010-029	A0-E010-029	1	Breaker 6A
8	A0-E036-007	A0-E036-007	2	Power connection kit for reversing
9	A0-E031-019	A0-E031-019	1	Watch dog timer
10	A0-E050-002	A0-E050-002	1	Bridge rectifier
11	A0-E004-071	A0-E004-071	3	Magnetic contactor (208-240V)
	A0-E004-069	A0-E004-069	3	Magnetic contactor (380-440V)
12	A0-E025-060	A0-E025-060	1	Overload (208-240V)
	A0-E025-058	A0-E025-058	1	Overload (380-440V)
13	A0-E031-025	A0-E031-025	1	Timer relay
	A0-E031-026	A0-E031-026	1	Socket timer relay
14	A0-E023-003	A0-E023-003	1	Proximity sensor

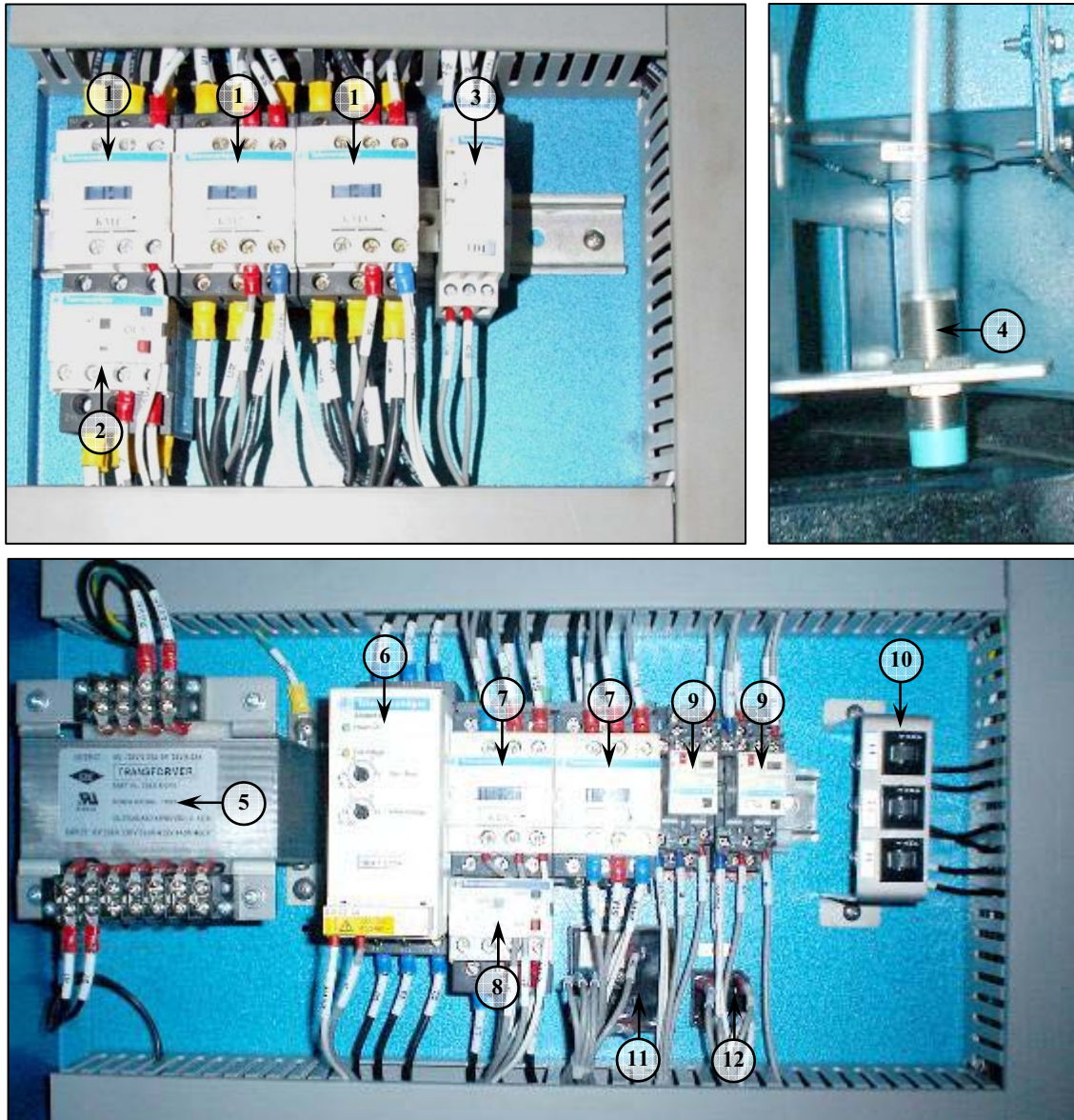

Item	Part No.		Qty.	Description
	DP200	DP250		
1	A0-E004-003	A0-E004-003	3	Magnetic contactor (208-240V)
	A0-E004-001	A0-E004-001	1	Magnetic contactor (380-440V)
2	A0-E025-010	A0-E025-010	1	Overload (208-240V)
	A0-E025-026	A0-E025-026	1	Overload (380-440V)
3	A0-E031-009	A0-E031-009	1	Timer relay
4	A0-E023-003	A0-E023-003	1	Proximity sensor
5	A0-E006-031	A0-E006-031	1	Transformer
6	A0-E026-010	A0-TSE01-086	1	Soft start (208-240V)
	A0-E026-006	A0-E026-010	1	Soft start (380-440V)
7	A0-E004-011	A0-E004-011	2	Magnetic contactor
8	A0-E025-020	A0-E025-020	1	Overload
9	A0-E009-070	A0-E009-070	2	Relay
	A0-E009-071	A0-E009-071	2	Socket relay
10	A0-E010-029	A0-E010-029	1	Breaker 6A
	A0-E010-034	A0-E010-034	2	Breaker 3A
11	A0-E031-019	A0-E031-019	1	Watch dog timer relay
12	A0-E050-002	A0-E050-002	1	Bridge rectifier

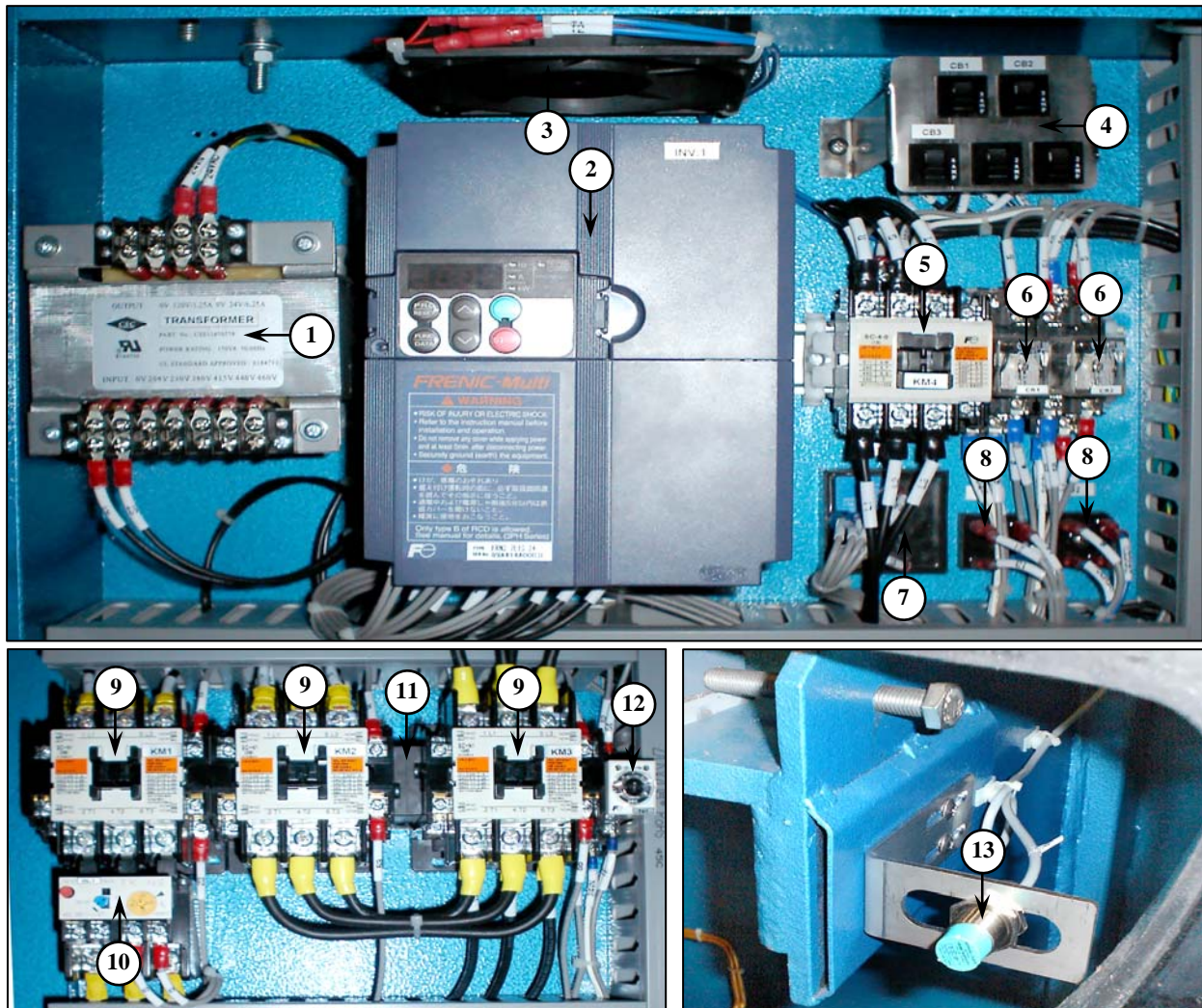

Item	Part No.		Qty.	Description
	DP200	DP250		
1	A0-E006-031	A0-E006-031	1	Transformer
2	A0-E026-006	A0-E026-010	1	AC Drive inverter (208-240V)
3	A0-E012-006	A0-E012-006	1	Fan, Cooling
	A0-E012-009	A0-E012-009	1	Filter for fan
4	A0-E010-029	A0-E010-029	1	Breaker 6A
	A0-E010-034	A0-E010-034	2	Breaker 3A
	A0-E010-035	A0-E010-035	2	Breaker 2A
5	A0-E004-069	A0-E004-069	1	Magnetic contactor
6	A0-E009-082	A0-E009-082	2	Relay
	A0-E009-083	A0-E009-083	2	Socket relay
7	A0-E031-019	A0-E031-019	1	Watch dog timer relay
8	A0-E050-002	A0-E050-002	1	Bridge rectifier
9	A0-E004-071	A0-E004-071	3	Magnetic contactor (208-240V)
	A0-E004-069	A0-E004-069	3	Magnetic contactor (380-440V)
10	A0-E025-060	A0-E025-060	1	Overload (208-240V)
	A0-E025-058	A0-E025-058	1	Overload (380-440V)
11	A0-E036-006	A0-E036-006	1	Mechanical interlock
12	A0-E031-025	A0-E031-025	1	Timer relay
	A0-E031-026	A0-E031-026	1	Socket timer relay
13	A0-E023-003	A0-E023-003	1	Proximity sensor

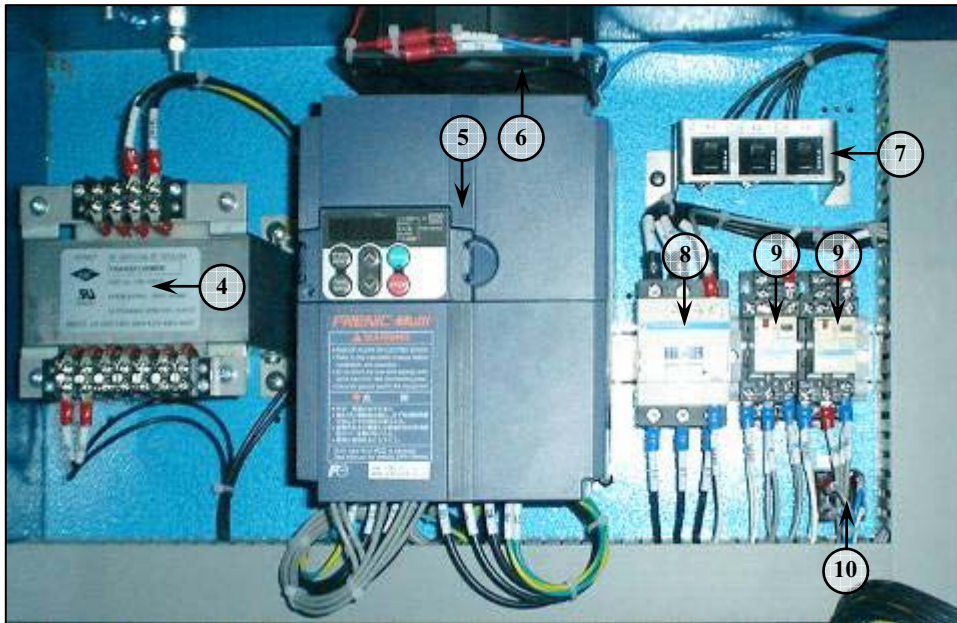
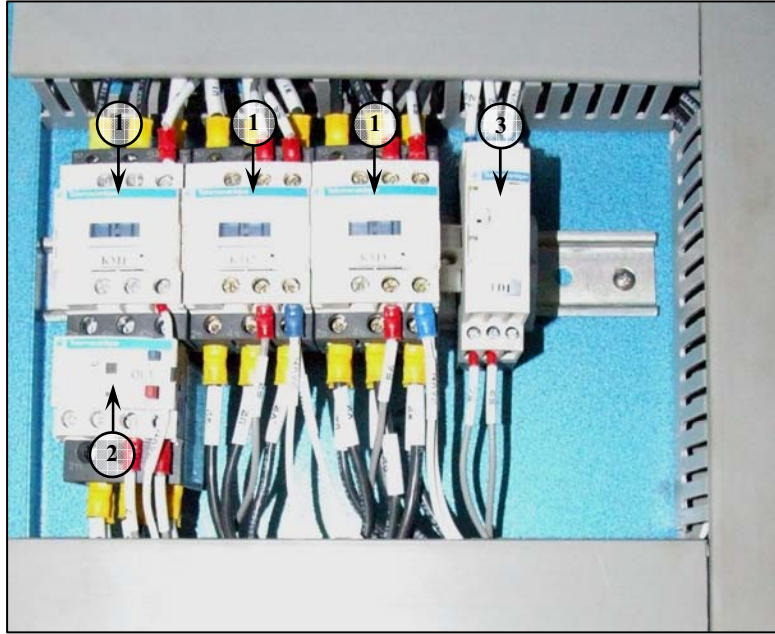

Item	Part No.		Qty.	Description
	DP200	DP250		
1	A0-E004-003	A0-E004-003	3	Magnetic contactor (208-240V)
	A0-E004-001	A0-E004-001	1	Magnetic contactor (380-440V)
2	A0-E025-010	A0-E025-010	1	Overload (208-240V)
	A0-E025-026	A0-E025-026	1	Overload (380-440V)
3	A0-E031-009	A0-E031-009	1	Timer relay
4	A0-E006-031	A0-E006-031	1	Transformer
5	A0-E026-006	A0-E026-010	1	AC Drive inverter (208-240V)
6	A0-E012-006	A0-E012-006	1	Fan, Cooling
	A0-E012-009	A0-E012-009	1	Filter for fan
7	A0-E010-029	A0-E010-029	1	Breaker 6A
	A0-E010-034	A0-E010-034	2	Breaker 3A
8	A0-E004-001	A0-E004-001	1	Magnetic contactor
9	A0-E009-070	A0-E009-070	1	Relay
	A0-E009-071	A0-E009-071	1	Socket relay
10	A0-E050-002	A0-E050-002	1	Bridge rectifier



More information is available on our website:  
[www.bandctech.com](http://www.bandctech.com)

©2008, B&C Technologies, LLC  
All Rights Reserved

---

---